

ERECTOR NOTE:
 BACK BED WITH SEALANT BEFORE
 THE WINDOW IS INSTALLED OR CAP
 SEAL AFTER THE WINDOW IS INSTALLED
 TO INSURE A WATERTIGHT SEAL.

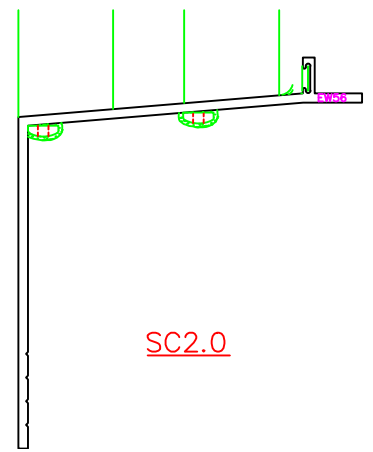
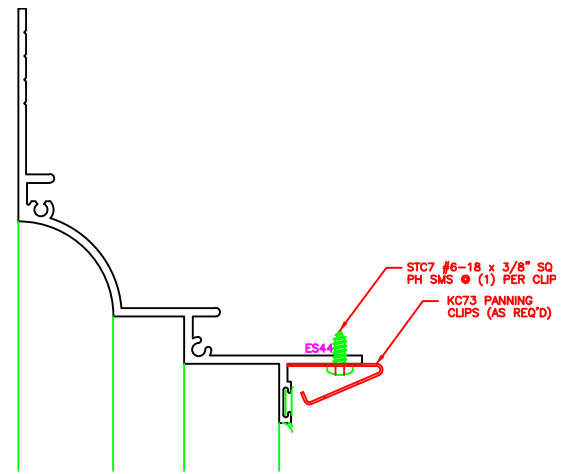

SC2.0